



### ■ General Description

The AME8801/8840 family of positive, linear regulators feature low quiescent current (30µA typ.) with low drop-out voltage, making them ideal for battery applications. The space-saving SOT-23-5 package is attractive for "Pocket" and "Hand Held" applications.

These rugged devices have both Thermal Shutdown, and Current Fold-back to prevent device failure under the "Worst" of operating conditions.

In applications requiring a low noise, regulated supply, place a 1000 pF capacitor between Bypass and Ground.

The AME8801 is stable with an output capacitance of 2.2µF or greater.

### ■ Features

- Very Low Dropout Voltage
- Guaranteed 300mA Output
- Accurate to within 1.5%
- 30µA Quiescent Current
- Over-Temperature Shutdown
- Current Limiting
- Short Circuit Current Fold-back
- Noise Reduction Bypass Capacitor
- Power-Saving Shutdown Mode
- Space-Saving SOT-25 (SOT-23-5) Package
- Factory Pre-set Output Voltages
- Low Temperature Coefficient

### ■ Functional Block Diagram

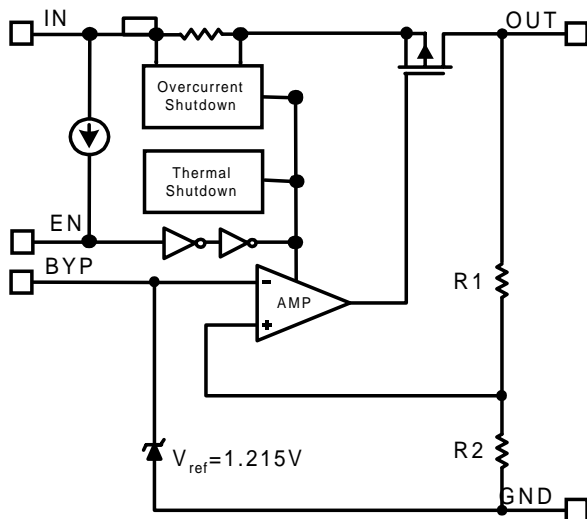

### ■ Applications

- Instrumentation
- Portable Electronics
- Wireless Devices
- Cordless Phones
- PC Peripherals
- Battery Powered Widgets
- Electronic Scales

### ■ Typical Application

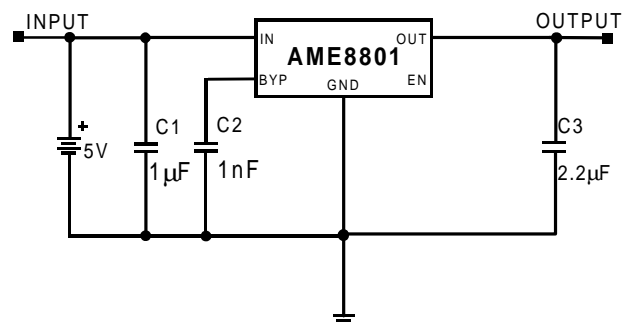



### ■ Pin Configuration

AME8801  
SOT-25 Top View

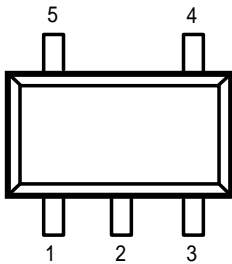

- 1.  $V_{IN}$
- 2. GND
- 3. EN
- 4. BYP
- 5. OUT

AME8801  
SOT-26 Top View

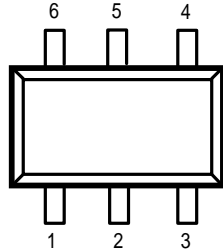

- 1. OUT\_1
- 2. GND
- 3. BYP
- 4. EN
- 5.  $V_{IN\_2}$
- 6. OUT\_2

AME8812  
SOT-25 Top View

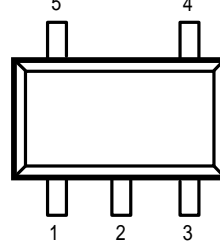

- 1. EN
- 2. GND
- 3.  $V_{IN}$
- 4. OUT
- 5. BYP

AME8840  
SOT-25 Top View

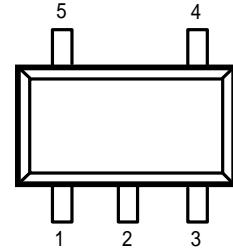

- 1. EN
- 2. GND
- 3. BYP
- 4. OUT
- 5.  $V_{IN}$

### ■ Ordering Information

Part Number	Marking	Output Voltage	Package	Operating Temp. Range
AME8801AEEV	AAFww	3.3V	SOT-25	-40°C to +85°C
AME8801BEEV	AAGww	3.0V	SOT-25	-40°C to +85°C
AME8801CEEV	AAHww	2.8V	SOT-25	-40°C to +85°C
AME8801DEEV	AAIww	2.5V	SOT-25	-40°C to +85°C
AME8801EEEV	AAJww	3.8V	SOT-25	-40°C to +85°C
AME8801FEEV	ABOww	3.6V	SOT-25	-40°C to +85°C
AME8801GEEV	ACFww	3.5V	SOT-25	-40°C to +85°C
AME8801HEEV	AEGww	2.7V	SOT-25	-40°C to +85°C
AME8801IEEV	AEOww	3.4V	SOT-25	-40°C to +85°C
AME8801JEEV	AGQww	2.85V	SOT-25	-40°C to +85°C
AME8801KEEV	AHSww	3.7V	SOT-25	-40°C to +85°C
AME8801LEEV	AJOww	1.5V	SOT-25	-40°C to +85°C
AME8801MEEV	AJPww	1.8V	SOT-25	-40°C to +85°C
AME8801NEEV	AKOww	2.9V	SOT-25	-40°C to +85°C
AME8801OEEV	AKPww	3.1V	SOT-25	-40°C to +85°C
AME8801SEEV	AQXww	5.0V	SOT-25	-40°C to +85°C
AME8801JEEY	ARUww	2.85V	SOT-26	-40°C to +85°C

Please consult AME sales office or authorized Rep./Distributor for other output voltage and package type availability.



■ Ordering Information

Part Number	Output Voltage	Package	Operating Temp. Range
AME8812AEEV	3.3V	SOT-25	-40°C to +85°C
AME8812BEEV	3.0V	SOT-25	-40°C to +85°C
AME8812CEEV	2.8V	SOT-25	-40°C to +85°C
AME8812DEEV	2.5V	SOT-25	-40°C to +85°C
AME8812EEEV	3.8V	SOT-25	-40°C to +85°C
AME8812FEEV	3.6V	SOT-25	-40°C to +85°C
AME8812GEEV	3.5V	SOT-25	-40°C to +85°C
AME8812HEEV	2.7V	SOT-25	-40°C to +85°C
AME8812IEEV	3.4V	SOT-25	-40°C to +85°C
AME8812JEEV	2.85V	SOT-25	-40°C to +85°C
AME8812KEEV	3.7V	SOT-25	-40°C to +85°C
AME8812LEEV	1.5V	SOT-25	-40°C to +85°C
AME8812MEEV	1.8V	SOT-25	-40°C to +85°C
AME8812NEEV	2.9V	SOT-25	-40°C to +85°C
AME8812OEEV	3.1V	SOT-25	-40°C to +85°C

Please consult AME sales office or authorized Rep./Distributor for other output voltage and package type availability.



### ■ Ordering Information

Part Number	Marking	Output Voltage	Package	Operating Temp. Range
AME8840AEEV	ALCww	3.3V	SOT-25	-40°C to +85°C
AME8840BEEV	ALDww	3.0V	SOT-25	-40°C to +85°C
AME8840CEEV	ALEww	2.8V	SOT-25	-40°C to +85°C
AME8840DEEV	ALFww	2.5V	SOT-25	-40°C to +85°C
AME8840EEEV	ALGww	3.8V	SOT-25	-40°C to +85°C
AME8840FEEV	ALHww	3.6V	SOT-25	-40°C to +85°C
AME8840GEEV	ALlww	3.5V	SOT-25	-40°C to +85°C
AME8840HEEV	ALJww	2.7V	SOT-25	-40°C to +85°C
AME8840IEEV	ALKww	3.4V	SOT-25	-40°C to +85°C
AME8840JEEV	ALLww	2.85V	SOT-25	-40°C to +85°C
AME8840KEEV	ALMww	3.7V	SOT-25	-40°C to +85°C
AME8840LEEV	ALNww	1.5V	SOT-25	-40°C to +85°C
AME8840MEEV	ALOww	1.8V	SOT-25	-40°C to +85°C
AME8840NEEV	ALPww	2.9V	SOT-25	-40°C to +85°C
AME8840OEEV	ALQww	3.1V	SOT-25	-40°C to +85°C

Please consult AME sales office or authorized Rep./Distributor for other output voltage and package type availability.



■ Absolute Maximum Ratings

Parameter	Maximum	Unit
Input Voltage	8	V
Output Current	$P_D / (V_{IN} - V_O)$	mA
Output Voltage	GND - 0.3 to $V_{IN} + 0.3$	V
ESD Classification	B	

■ Recommended Operating Conditions

Parameter	Rating	Unit
Ambient Temperature Range	-40 to +85	°C
Junction Temperature	-40 to +125	°C

■ Thermal Information

Parameter		Maximum	Unit
Thermal Resistance ( $q_{ja}$ )	SOT-25	260	°C / W
Internal Power Dissipation ( $P_D$ ) (DT = 100°C)	SOT-25	380	mW
Thermal Resistance ( $q_{ja}$ )	SOT-26	260	°C / W
Internal Power Dissipation ( $P_D$ ) (DT = 100°C)	SOT-26	380	mW
Maximum Junction Temperature		150	°C

**Caution: Stress above the listed absolute rating may cause permanent damage to the device**



### ■ Electronic Specifications

TA = 25°C unless otherwise noted

Parameter	Symbol	Test Condition	Min	Typ	Max	Units	
Input Voltage	V <sub>IN</sub>		Note 1		7	V	
Output Voltage Accuracy	V <sub>O</sub>	I <sub>O</sub> =1mA	-1.5		1.5	%	
Dropout Voltage	V <sub>DROPOUT</sub>	I <sub>O</sub> =300mA V <sub>O</sub> =V <sub>ONOM</sub> -2.0%	1.2V<V <sub>O(NOM)</sub> <=2.0V	See chart	1300	mV	
			2.0V<V <sub>O(NOM)</sub> <=2.8V		400		
			2.8V<V <sub>O(NOM)</sub>		300		
Output Current	I <sub>O</sub>	V <sub>O</sub> >1.2V	300			mA	
Current Limit	I <sub>LIM</sub>	V <sub>O</sub> >1.2V	300	450		mA	
Short Circuit Current	I <sub>SC</sub>	V <sub>O</sub> <0.8V		150	300	mA	
Quiescent Current	I <sub>Q</sub>	I <sub>O</sub> =0mA		30	50	μA	
Ground Pin Current	I <sub>GND</sub>	I <sub>O</sub> =1mA to 300mA		35		μA	
Line Regulation	REG <sub>LINE</sub>	I <sub>O</sub> =1mA V <sub>IN</sub> =V <sub>O</sub> +1 to V <sub>O</sub> +2	V <sub>O</sub> < 2.0V	-0.15		0.15	%
			2.0V<=V <sub>O</sub> < 4.0V	-0.1	0.02	0.1	%
			4.0V <= V <sub>O</sub>	-0.4	0.2	0.4	%
Load Regulation	REG <sub>LOAD</sub>	I <sub>O</sub> =1mA to 300mA	-1	0.2	1	%	
Over Temperature Shutdown	OTS			150		°C	
Over Temperature Hysteresis	OTH			30		°C	
V <sub>O</sub> Temperature Coefficient	TC			30		ppm/°C	
Power Supply Rejection	PSRR	I <sub>O</sub> =100mA C <sub>O</sub> =2.2μF	f=1kHz		50	dB	
			f=10kHz		20		
			f=100kHz		15		
Output Voltage Noise	e <sub>N</sub>	f=10Hz to 100kHz I <sub>O</sub> =10mA			30	μVrms	
EN Input Threshold	V <sub>EH</sub>	V <sub>IN</sub> =2.7V to 7V	2.0		V <sub>in</sub>	V	
	V <sub>EL</sub>	V <sub>IN</sub> =2.7V to 7V	0		0.4	V	
EN Input Bias Current	I <sub>EH</sub>	V <sub>EN</sub> =V <sub>IN</sub> , V <sub>IN</sub> =2.7V to 7V			0.1	μA	
	I <sub>EL</sub>	V <sub>EN</sub> =0V, V <sub>IN</sub> =2.7V to 7V			0.5	μA	
Shutdown Supply Current	I <sub>SD</sub>	V <sub>IN</sub> =5V, V <sub>O</sub> =0V, V <sub>EN</sub> <V <sub>EL</sub>		0.5	1	μA	
Shutdown Output Voltage	V <sub>O,SD</sub>	I <sub>O</sub> =0.4mA, V <sub>EN</sub> <V <sub>EL</sub>	0		0.4	V	

Note1: V<sub>IN(min)</sub>=V<sub>OUT</sub>+V<sub>DROPOUT</sub>



### ■ Detailed Description

The AME8801/8840 family of CMOS regulators contain a PMOS pass transistor, voltage reference, error amplifier, over-current protection, and thermal shutdown.

The P-channel pass transistor receives data from the error amplifier, over-current shutdown, and thermal protection circuits. During normal operation, the error amplifier compares the output voltage to a precision reference. Over-current and Thermal shutdown circuits become active when the junction temperature exceeds 150°C, or the current exceeds 300mA. During thermal shutdown, the output voltage remains low. Normal operation is restored when the junction temperature drops below 120°C.

The AME8801/8840 switches from voltage mode to current mode when the load exceeds the rated output current. This prevents over-stress. The AME8801/8840 also incorporates current foldback to reduce power dissipation when the output is short circuited. This feature becomes active when the output drops below 0.8volts, and reduces the current flow by 65%. Full current is restored when the voltage exceeds 0.8 volts.

### ■ External Capacitors

The AME8801/8840 is stable with an output capacitor to ground of 2.2 $\mu$ F or greater. Ceramic capacitors have the lowest ESR, and will offer the best AC performance. Conversely, Aluminum Electrolytic capacitors exhibit the highest ESR, resulting in the poorest AC response. Unfortunately, large value ceramic capacitors are comparatively expensive. One option is to parallel a 0.1 $\mu$ F ceramic capacitor with a 10 $\mu$ F Aluminum Electrolytic. The benefit is low ESR, high capacitance, and low overall cost.

A second capacitor is recommended between the input and ground to stabilize  $V_{in}$ . The input capacitor should be at least 0.1 $\mu$ F to have a beneficial effect.

A third capacitor can be connected between the BY-PASS pin and GND. This capacitor can be a low cost Polyester Film variety between the value of 0.001 ~ 0.01 $\mu$ F. A larger capacitor improves the AC ripple rejection, but also makes the output come up slowly. This "Soft" turn-on is desirable in some applications to limit turn-on surges.

All capacitors should be placed in close proximity to the pins. A "Quiet" ground termination is desirable. This can be achieved with a "Star" connection.

### ■ Enable

The Enable pin normally floats high. When actively, pulled low, the PMOS pass transistor shuts off, and all internal circuits are powered down. In this state, the quiescent current is less than 1 $\mu$ A. This pin behaves much like an electronic switch.

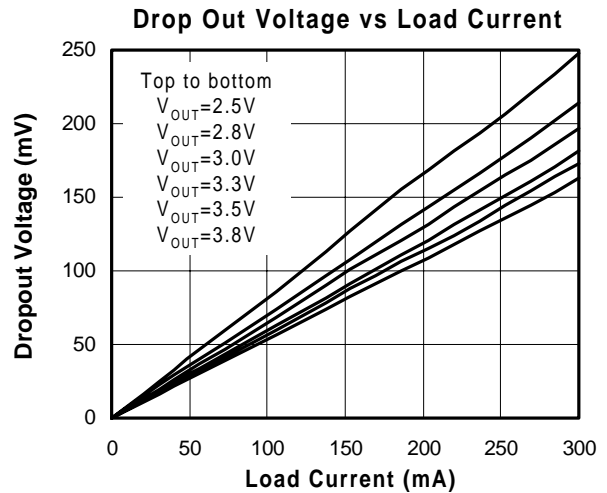
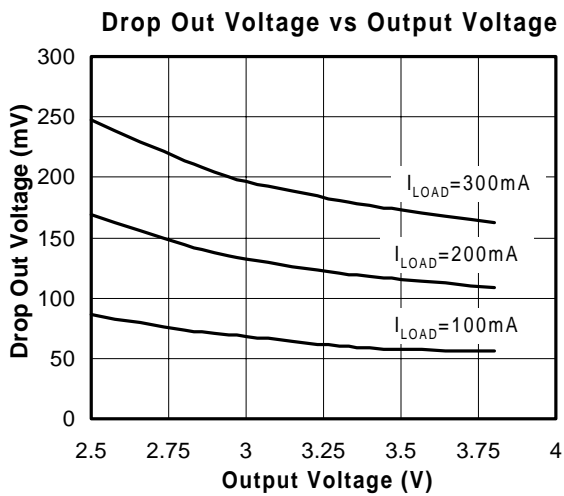
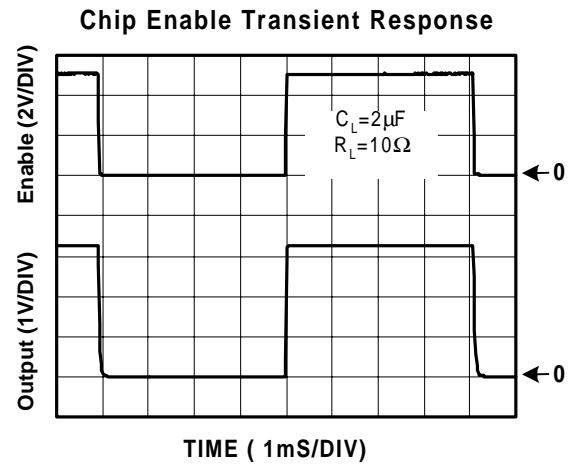
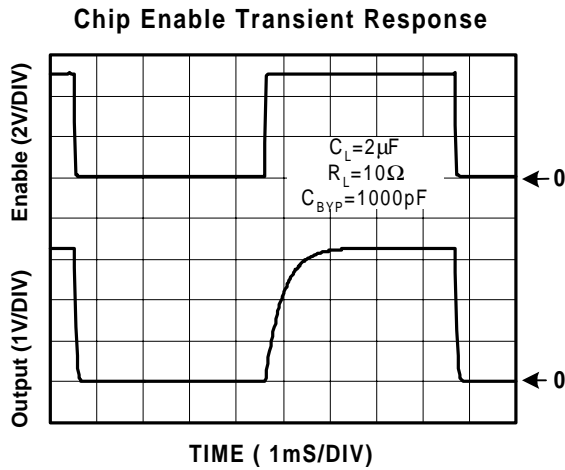
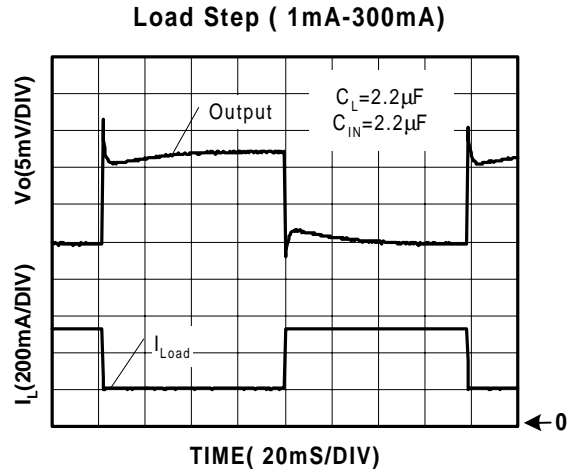
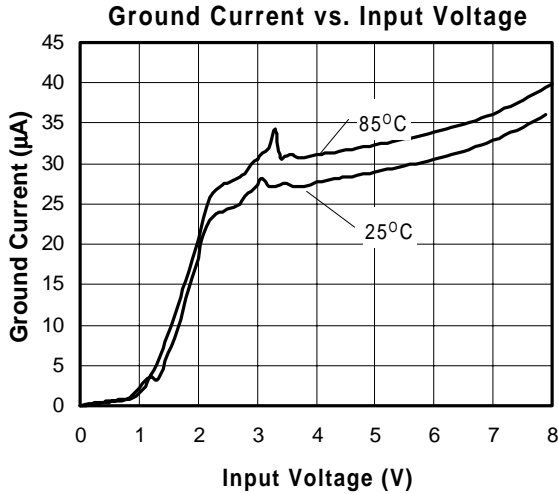



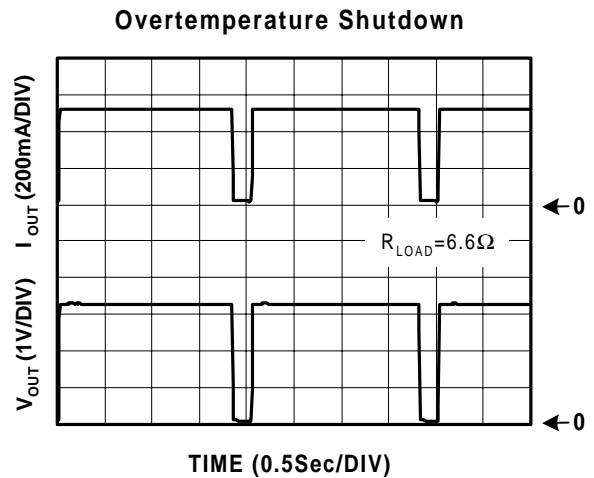
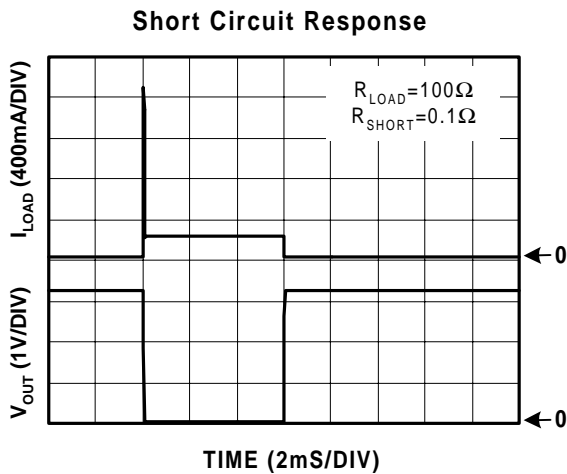
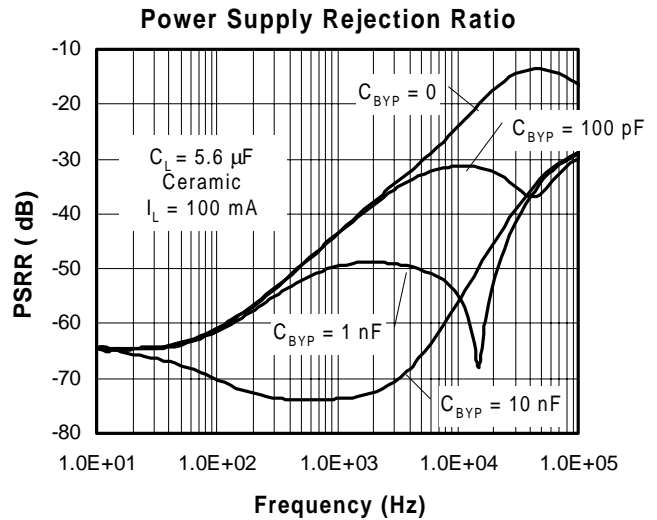
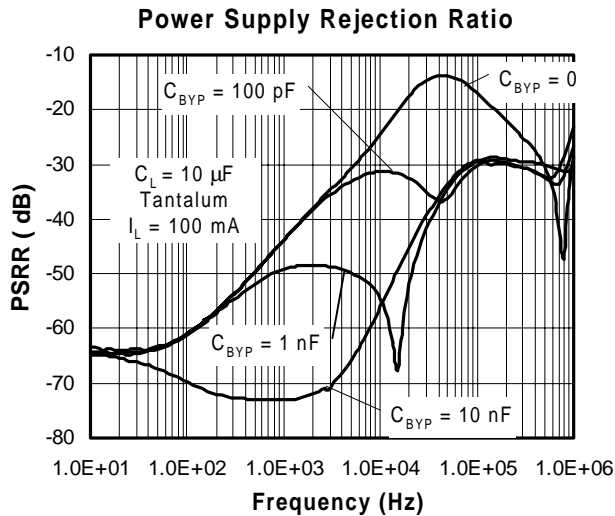
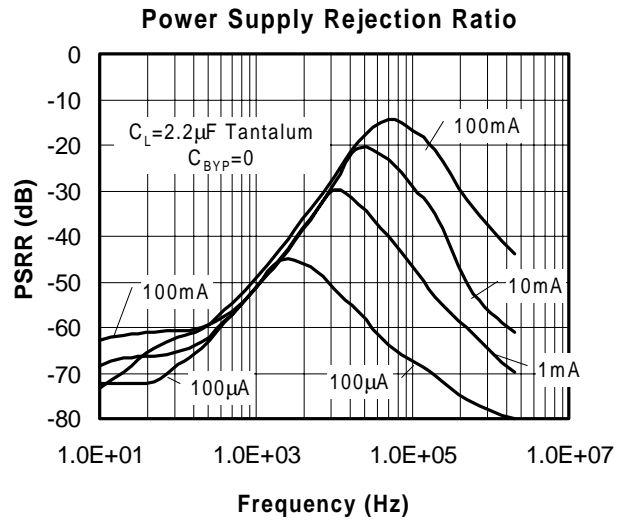
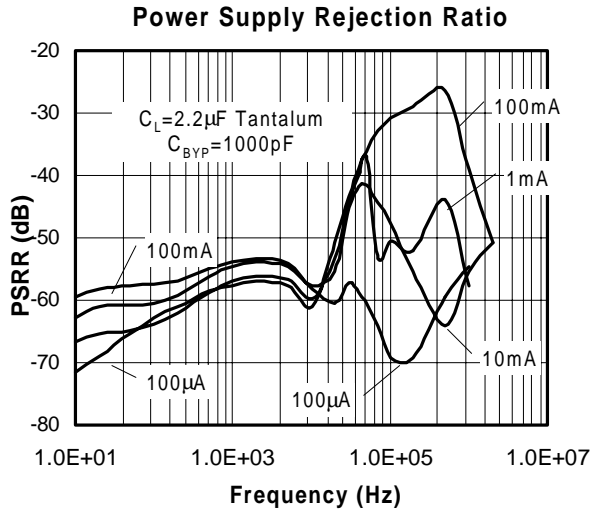

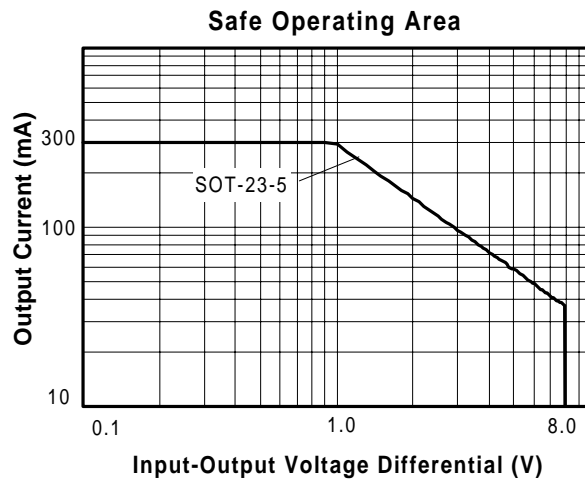
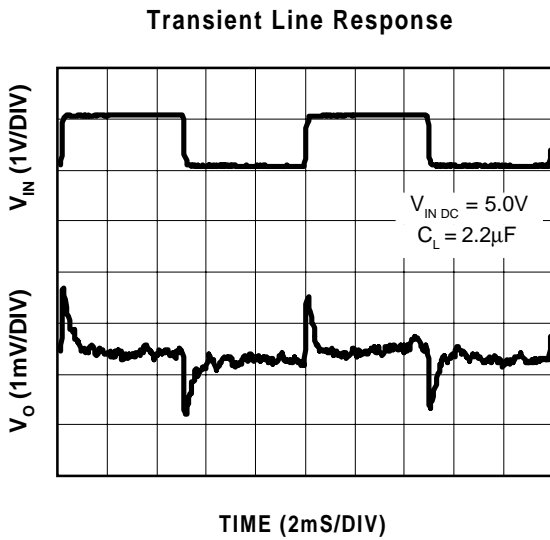
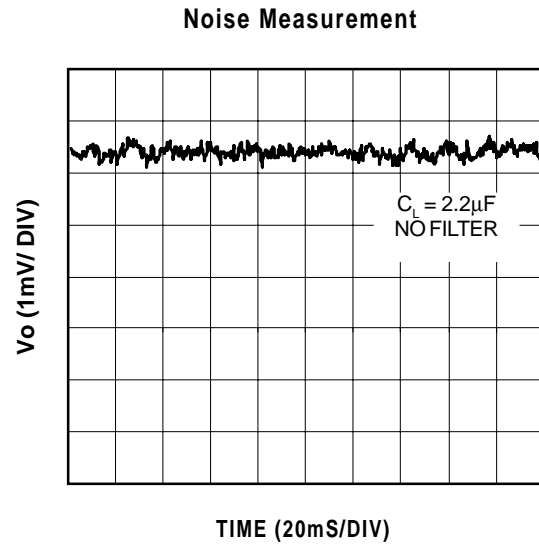
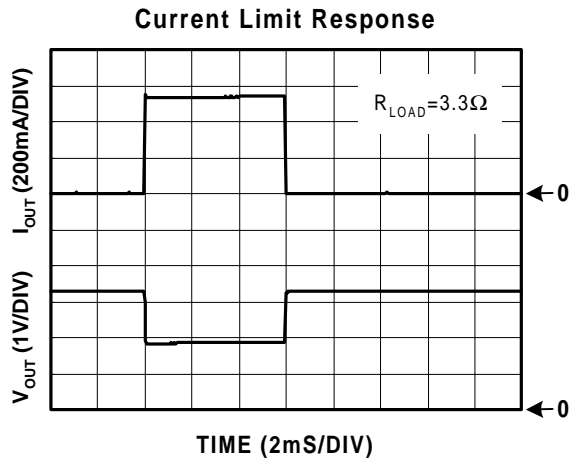

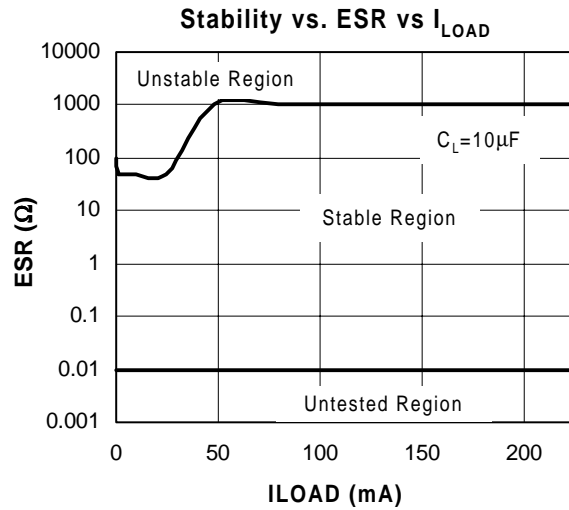
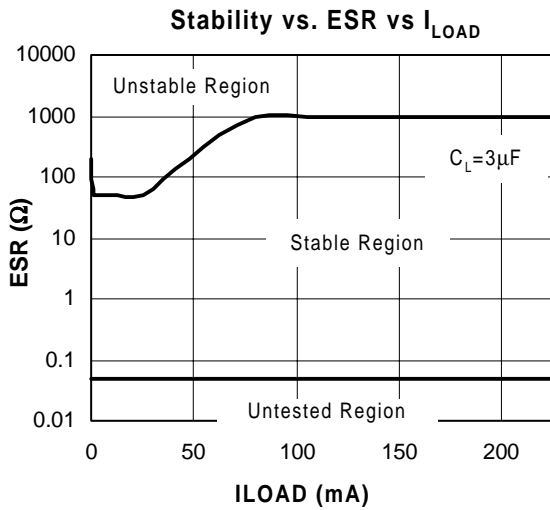
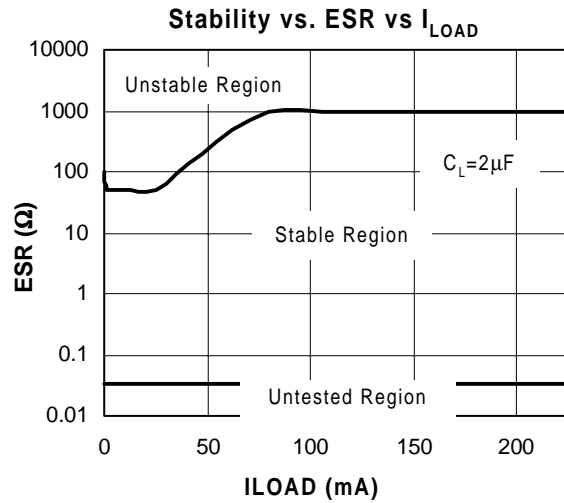
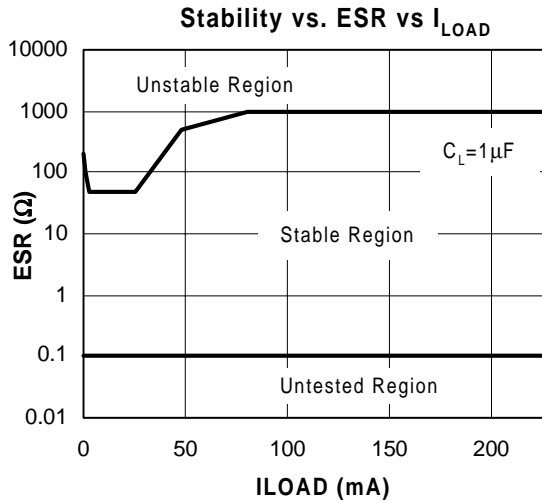



Quiescent Current vs.Temp.

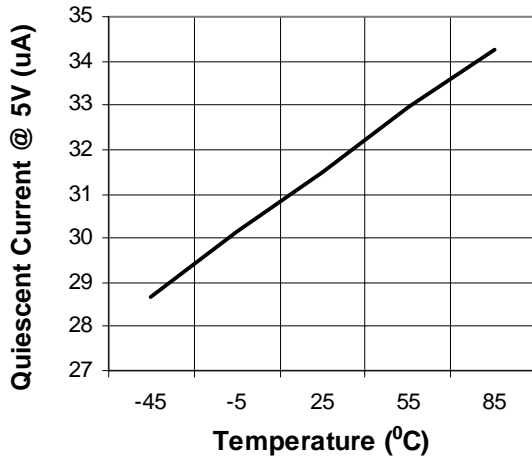

Load Regulation vs. Temp.

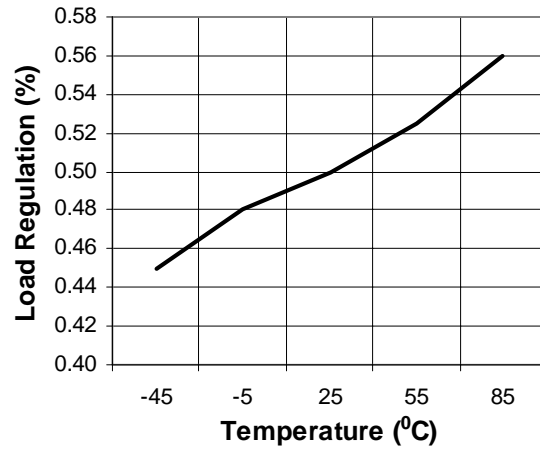

Shut Down Current vs. Temp.

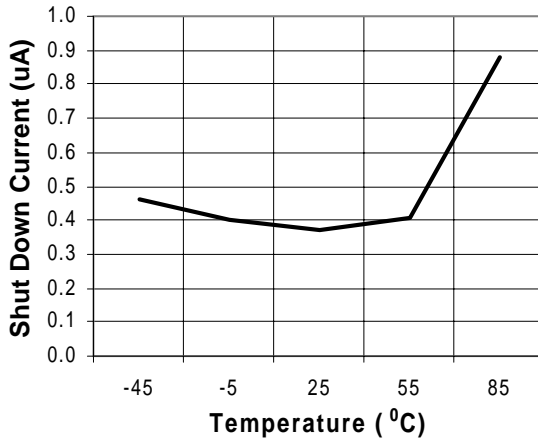

Dropout Voltage vs. Temp.

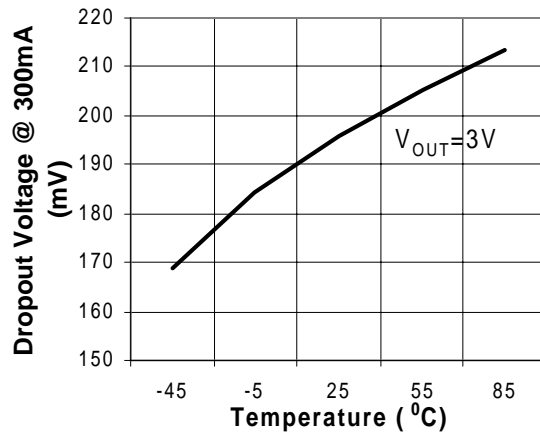

EN Pin LO Bias Current vs. Temp.

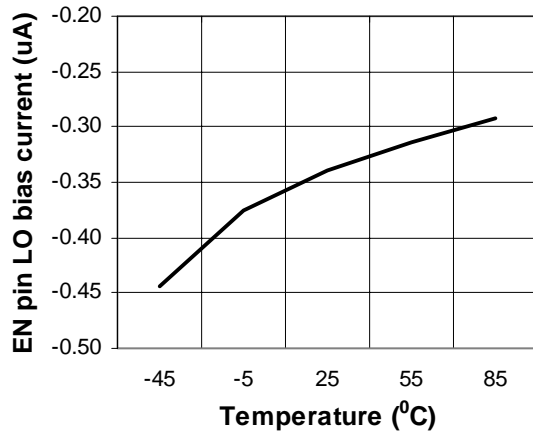



■ Package Dimension

SOT-25

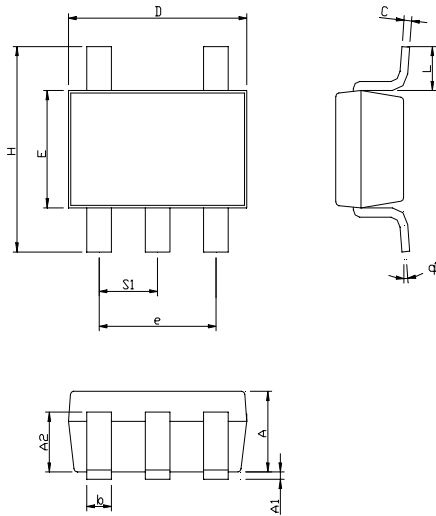

SYMBOLS	MILLIMETERS		INCHES	
	MIN	MAX	MIN	MAX
A	1.00	1.45	0.0394	0.0571
A <sub>1</sub>	0.00	0.15	0.0000	0.0591
A <sub>2</sub>	0.70	1.25	0.0276	0.0492
b	0.35	0.55	0.0138	0.0217
C	0.08	0.25	0.0031	0.0098
D	2.70	3.10	0.1063	0.1220
E	1.40	1.80	0.0551	0.0709
e	1.90 BSC		0.07480 BSC	
H	2.60	3.00	0.1024	0.1181
L	0.30	-	0.0118	-
θ <sub>1</sub>	0°	10°	0°	10°
S <sub>1</sub>	0.85	1.05	0.0335	0.0413

SOT-26

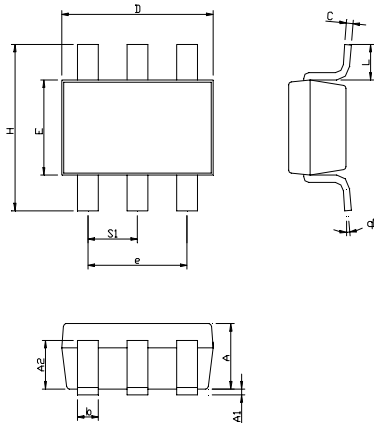

SYMBOLS	MILLIMETERS		INCHES	
	MIN	MAX	MIN	MAX
A	1.00	1.40	0.0394	0.0551
A <sub>1</sub>	0.00	0.15	0.0000	0.0591
A <sub>2</sub>	0.70	1.25	0.0276	0.0492
b	0.35	0.50	0.0138	0.0197
C	0.08	0.25	0.0031	0.0098
D	2.70	3.10	0.1063	0.1220
E	1.40	1.80	0.0551	0.0709
e	1.90 BSC		0.0748 BSC	
H	2.60	3.00	0.1024	0.1181
L	0.35	-	0.0138	-
θ <sub>1</sub>	0°	9°	0°	9°
S <sub>1</sub>	0.85	1.05	0.0335	0.0413



**www.analogmicro.com**  
**E-Mail: info@analogmicro.com**

Life Support Policy:

These products of Analog Microelectronics, Inc. are not authorized for use as critical components in life-support devices or systems, without the express written approval of the president of Analog Microelectronics, Inc.

Analog Microelectronics, Inc. reserves the right to make changes in the circuitry and specifications of its devices and advises its customers to obtain the latest version of relevant information.

© Analog Microelectronics, Inc. , August 2001

Document: 2006-DS8801/8812/8840-E

**Corporate Headquarters**  
**Analog Microelectronics, Inc.**

3100 De La Cruz Blvd. Suite 201  
Santa Clara, CA. 95054-2046  
Tel : (408) 988-2388  
Fax: (408) 988-2489

**Asia Pacific Headquarters**  
**AME, Inc.**

2F, 187 Kang-Chien Road, Nei-Hu District  
Taipei 114, Taiwan, R.O.C.  
Tel : 886 2 2627-8687  
Fax: 886 2 2659-2989